

# RularPRO MW EM

108870, 108871, 108872



Thank you for purchasing this light fitting. Please read the instructions carefully before use to ensure safe and satisfactory operation of this product. Please retain these instructions for future reference.

## Warning

This is a Class 1 product and must be earthed. Please read these instructions carefully before commencing any work. This unit must be fitted by a competent and qualified electrician. Check the pack and make sure you have all the parts listed. Install in accordance with the IEE Wiring regulations and current Building Regulations.

To prevent electrocution switch off at mains supply before installing or maintaining this fitting. Ensure other persons cannot restore the electrical supply without your knowledge. If you are in any doubt, please consult a qualified electrician.

This light fitting should be connected to a fused circuit.

If replacing an existing fitting, make a careful note of the connections.

Waste electrical products should not be disposed of with household waste. Please recycle where facilities exist. Check with your local authority or retailer for recycling advice.

## Layout

Plan the desired layout of these fittings carefully, ensuring the cables will reach the distances between the junction box and the each light fitting. Avoid locating any cables in positions that would cause a hazard. Position cables and outdoor rated junction boxes (not supplied) away from areas where they may be at risk from being cut, trapped or damaged. The mains supply cable must have a minimum cross section area of 1.0mm<sup>2</sup>. Cables must be protected using suitable conduit or plastic trunking.

Take care not to drill into any pipes or mains cables beneath the surface during mounting holes preparation.

This product can be installed on the ceiling or wall.

## Installation

Existing fittings must be completely removed before installation of a new product. Before removing the existing fitting, carefully note the position of each set of wires.

Note that the switch is turned off before installation.

The mounting surface must be flat and smooth to ensure a good fit.

The wattage is changeable by using the wattage switch on the driver.

For the 108870 is the 31.5W / 20W selectable  
20W 31.5W

For the 108871 is the 39W / 26W selectable  
26W 39W

For the 108872 is the 44W / 35W selectable  
35W 44W

The colour is changeable between 3000/4000/6000K using the CCT switch on the driver before installation. Choose your preferred wattage and colour before installing by wattage switch or CCT switch on the driver. Note: Before you change the wattage or colour, please turn off the power switch for safety.

- Hold the product in place and mark the position of the fixing holes. This may require the help of an assistant. If wall mounting, ensure that the product is level.
- Take care to avoid damaging any concealed wiring and pipes. The correct fixings should be used for bricks, cavity walls or plasterboard.
- Ensure the ceiling or wall is capable of holding the weight of the product and then fix brackets in place.
- Rotate both ends of the product in the direction of the arrow to open the diffuser cover.

## Technical data

Supply Voltage: 220-240 V~, 50 Hz  
Bulb Type: 108870 : 31.5W / 20W LED (SMD) CCT, 3000/4000 /6000K  
108871 : 39W / 26W LED (SMD) CCT, 3000/4000 /6000K  
108872 : 44W / 35W LED(SMD) CCT, 3000/4000 /6000K  
This product contains a light source of energy efficiency class **C**.

Non-replaceable light source

Replaceable control gear by a professional

Conformity with all relevant UKCA Directive requirements.

Conformity with all relevant EC Directive requirements.

This product is Class 1, must be connected to earth.

Waste electrical products should not be disposed of with household waste. Please recycle where facilities exist. Check with your Local Authority or local store for recycling advice.

This product is not suitable for dimming.

This product is for indoor use only.

## EM data

Duration: 3 hours (180 Minutes) Battery Specification: LiFePO4 3.2V 1500mAh  
Mains input current: 22mA Battery Charge Time: 24 Hours  
input power in mains operation: 2.5W Battery warranty: 5 years  
Emergency power: 1W (Battery) Operating Temperature: 0°C-45°C

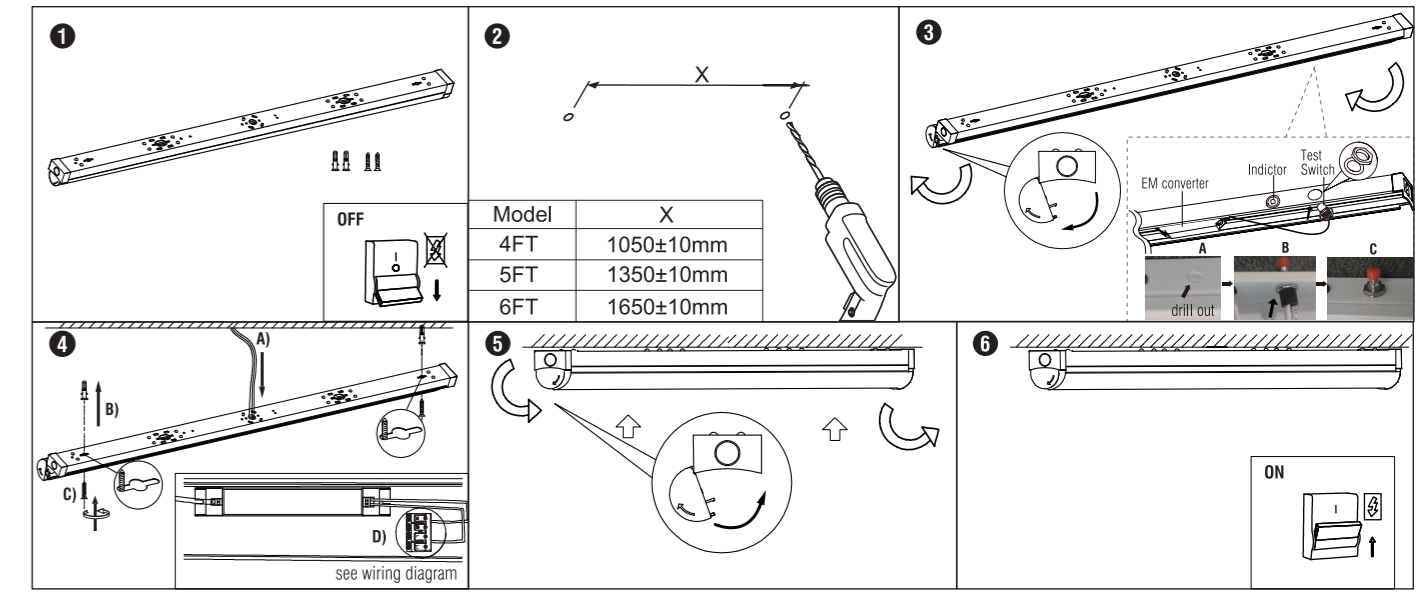
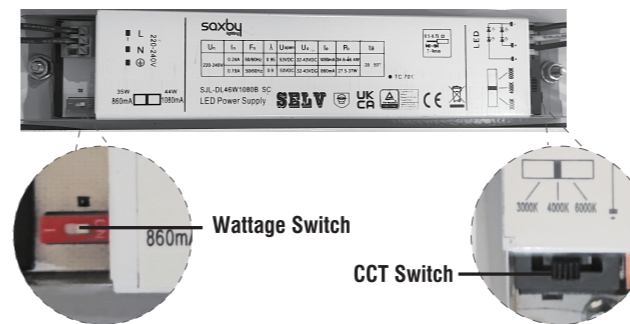

## Wiring

This product is Class I product must be earthed. Having correctly identified the wiring from your existing light fitting and connect to the connection block inside the product in the following way: Under the master slave mode, when maintaining the slave lamps, turn off the supply of both ends of the Master. To avoid the risk of electric shock.

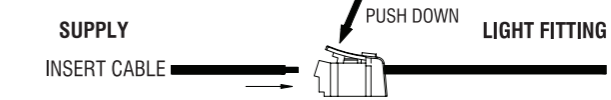

**Maintained(Unswitched) Wiring :** The product on permanently and comes on during a power failure.

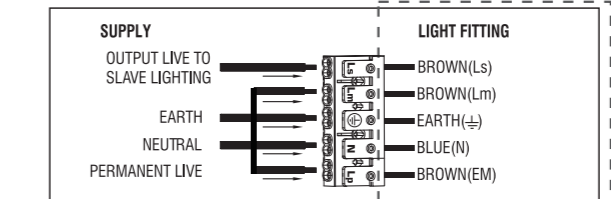

**Maintained (Switched) Wiring:** The product is used as a normal light - switch on/off, light turns on/off. Comes on during a power failure.

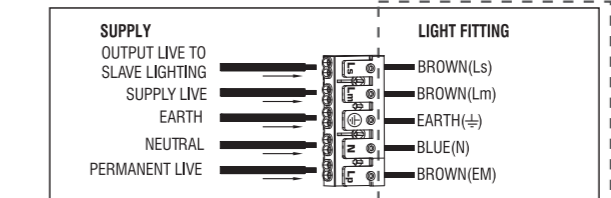

**Non-Maintained Wiring:** The product is normally off and comes on during a power failure.

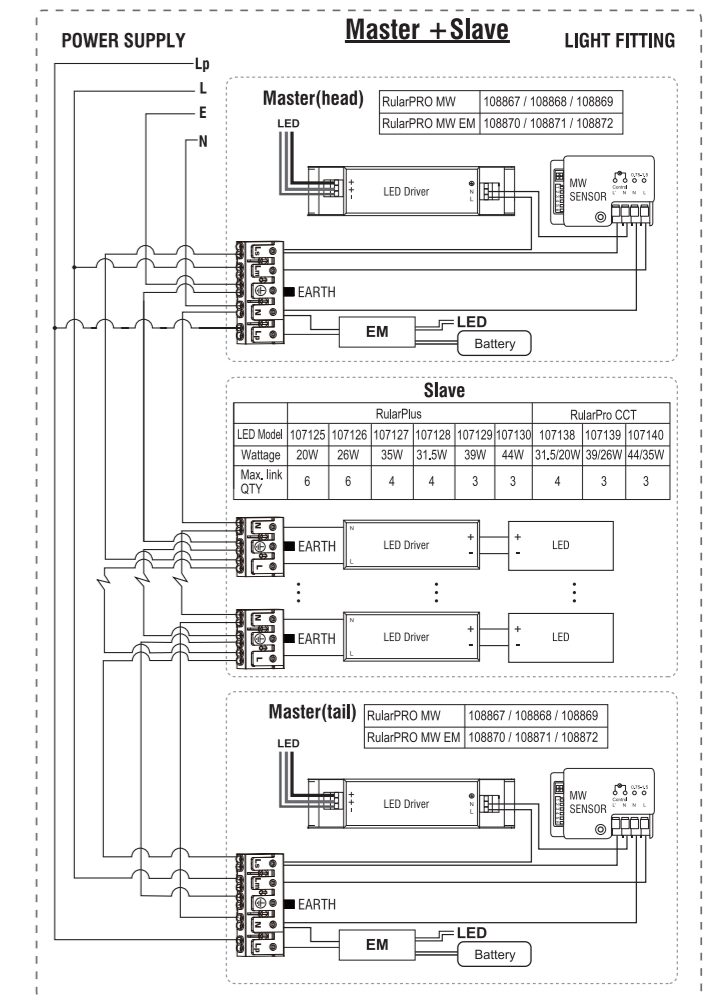
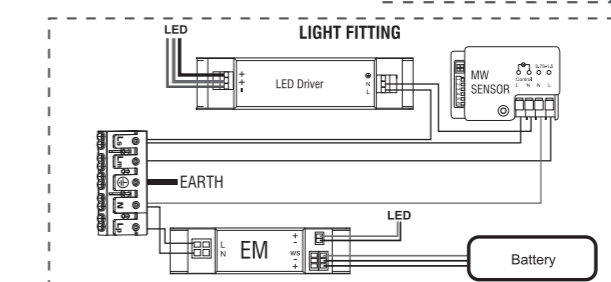
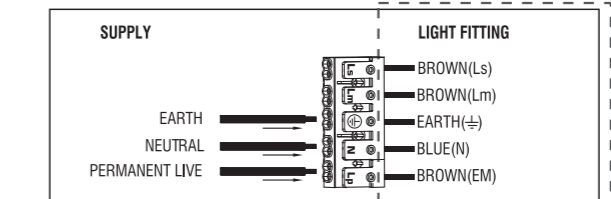

## Check that...

- You have correctly identified the wires.
- The connections are tight.
- No loose strands have been left out of the connection block.

## Microwave Movement Sensor



### DETACHED SENSOR ON/OFF FUNCTION

- 220-240VAC Input, ON/OFF Function
- Special Detached Design For More Applications
- DIP Switch Control, User Friendly
- 5 Years Warranty



### Mechanical structure

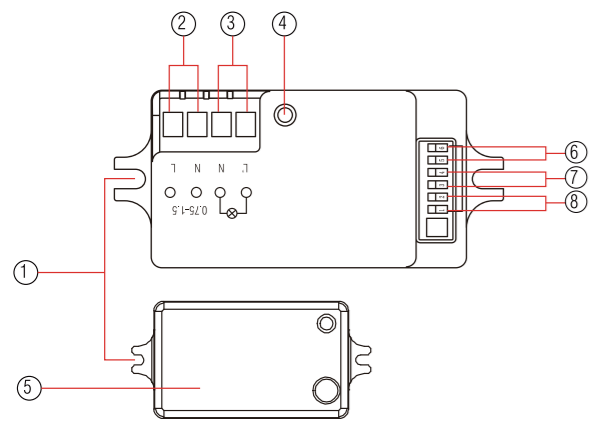

- ① Installation Hole
- ② Input
- ③ Output
- ④ Daylight Sensor
- ⑤ Microwave Module
- ⑥ Daylight Threshold
- ⑦ Hold Time
- ⑧ Detection Area

### Dimensions Unit:mm

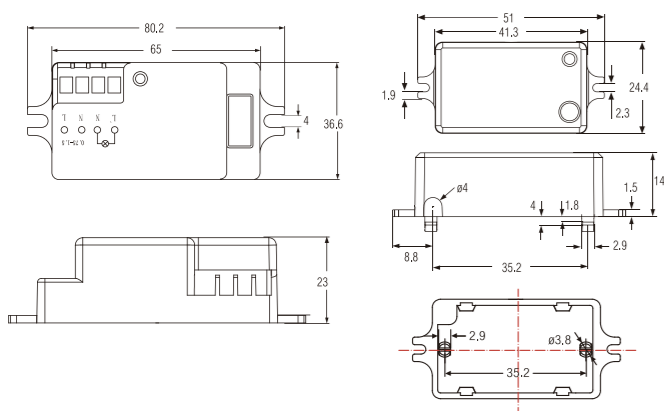

### Wiring Diagram

Shown-part length about 335mm

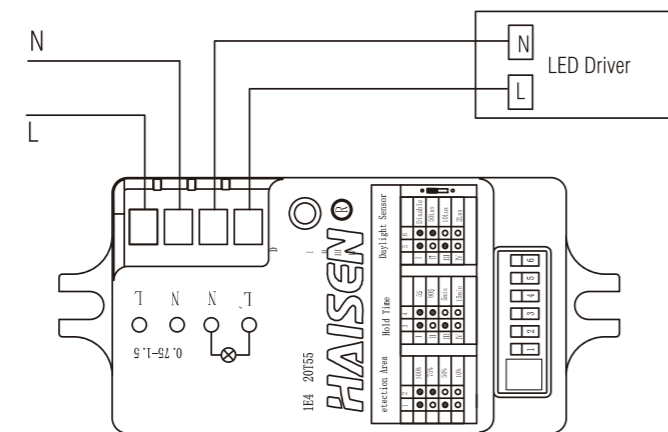

## Technical Data

Operating Voltage 220-240VAC 50/60Hz	Detection Area 10%/50%/75%/100%	Programming DIP
Stand-by Power ≤ 0.5W	Hold Time 5s/90s/5min/15min	Control ON/OFF
Microwave Frequency 5.8GHz ± 75MHz	Mounting Height Max. 4m/13.12ft Ceiling Mounted	Operating Temperature 25°C ~ +60°C
Microwave power < 0.3mW	Detection Range Max. ø14m/45.92ft Ceiling Mounted	Motion Detection 0.5~1.5m/s
Connection L.N.N.L*	Daylight Threshold 2Lux/10Lux/50Lux/Disable	IP Rating IP20
Detection Angle 30-150° Without Glass Cover	Switching capacity Max. 400W Control Gear; Max. 800W Incandescent lamp	Warranty 5 years

### Dial code setting

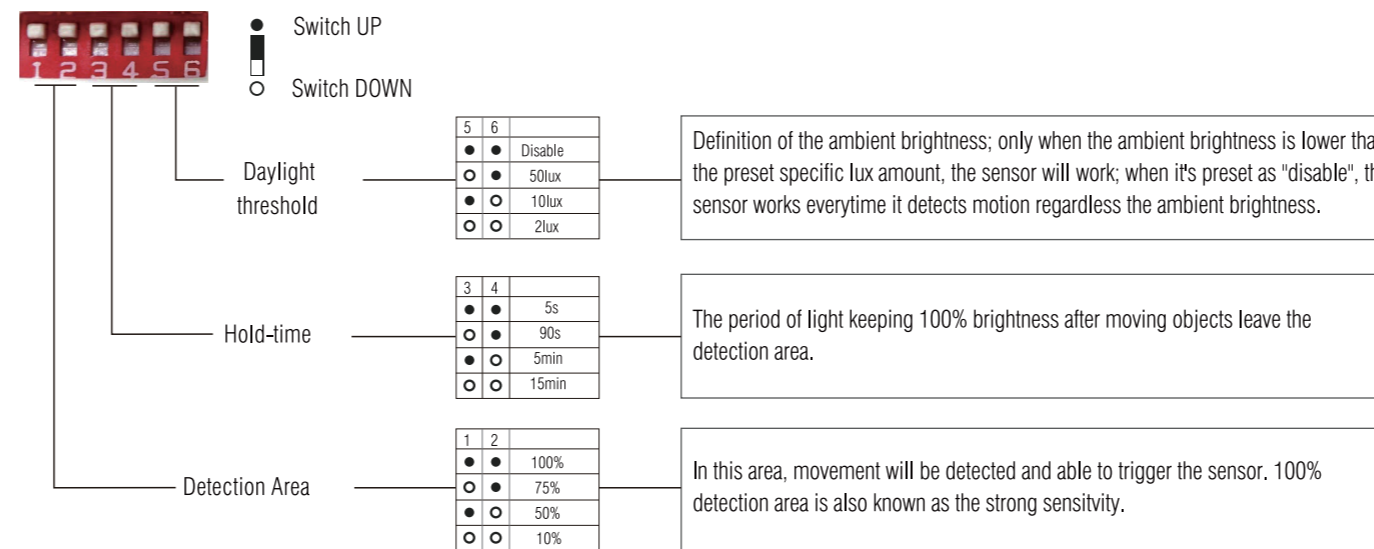

### Detection Patterns

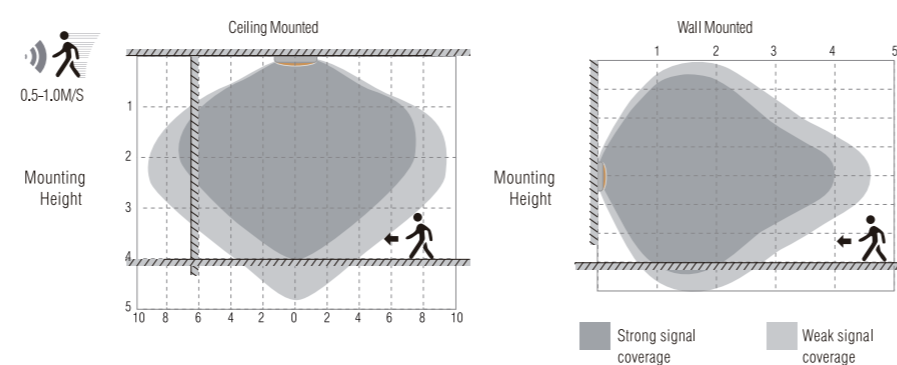

Highest mounting height is 4m

This figure indicates the maximum distance at the highest mounting height with 100% sensitivity.

## Performance

### 1) Automatically ON/OFF function

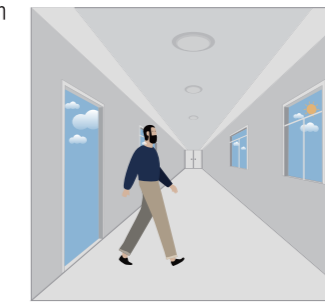

With sufficient daylight, even when motion detected, light remains OFF.

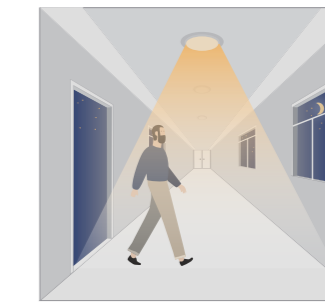

With insufficient daylight, the sensor turns light ON when motion gets detected.

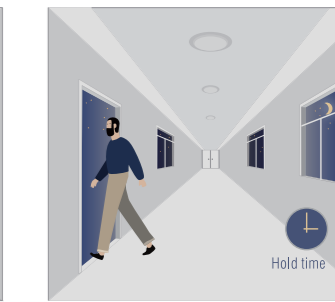

The sensor turns OFF light automatically after the holdtime when there's no motion detected.

### 2) Daylight Disable

When daylight threshold is preset as "disable", the sensor turns light ON when motion gets detected, and OFF after holdtime



The sensor turns light ON when motion gets detected.

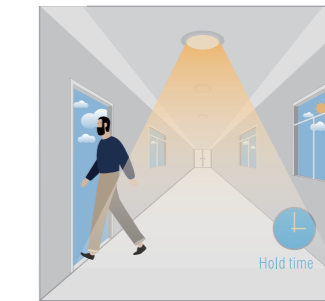

The sensor keeps light ON for holdtime period after motion leaves.

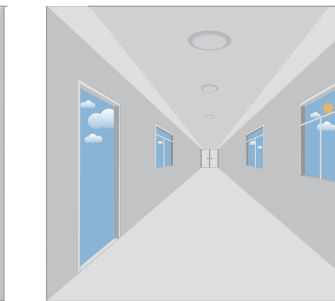

The sensor turns OFF light automatically after the holdtime.

### Installation precautions

1. Microwave sensor can be installed in any lamp except the one with full metal shell.
2. The detected surface cannot be shielded by metal objects.
3. Make sure the microwave module is completely exposed outside.
4. The detection surface of the sensor module shall be installed facing the detection area.
5. Should be kept away from the driver to avoid interference generation and lamp flashing.
6. Wiring must be strictly in accordance with the wiring diagram to avoid short circuit.

### User Notes

1. Microwave can penetrate walls or glass thinner than <20mm and attenuate if thicker than <20mm.
2. The driver voltage shall be stable and float within 10%.
3. Detection area will be affected by speed of motion, mounting height and movement volume.
4. Conduct test on sunny days without the lampshade which will affect the tested lux value.
5. 3M distance is suggested when having a lot sensors in one same room.
6. If the sensor is applied in the room with 5G WiFi router, 3M distance or above is needed.

### Application Environment

1. Suitable for indoor installation to avoid false triggering due to external factors such as rain, wind or tree swing.
2. Shall not be installed in the place with all four metal shelters and small space (such as galvanized-iron roof).
3. Shall not be mounted installation, so as to avoid false trigger caused by the lamp itself shaking.
4. Shall not be installed next to large operating machines such as ventilator/ceiling fan to avoid false triggering caused by machine vibration.
5. The sensor might be unwanted triggered in rooms that are small, or mostly filled with metal materials; please try to decrease sensitivity when it happens or contact us for support.

### Care and Safety

We recommend cleaning with a soft dry cloth. Do not use solvents or abrasive cleaners as these could damage the finish. For your safety, always switch off the power supply before cleaning.

For further information, please visit <https://www.lighting-info.co.uk/108867>

V6 06/03/2024  
**UK Manufacturer:** BH17 7BY  
**EU Manufacturer:** Brilliant AG,  
 Brilliantstrasse 1, D-27442 Gnarrenburg

**saxby**  
lighting